

新能源保护元器件 New Energy Protection Components

受控熔断器
idea Thermal-Link (iTCO)

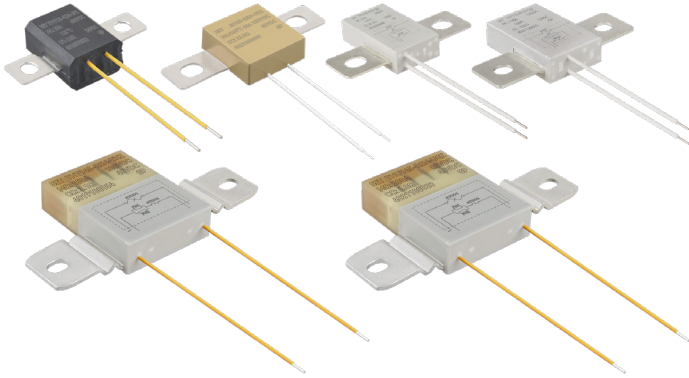

温度保险丝
Thermal-Link (DC-ATCO)

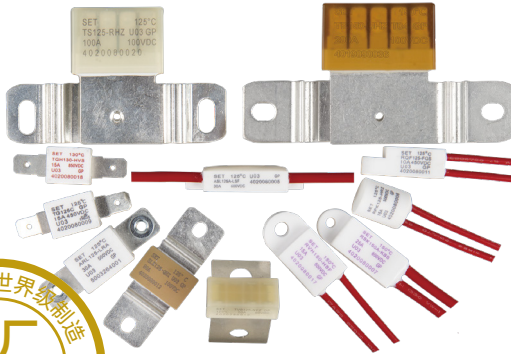

SET safe | SET fuse
赛尔特

制造电路控制及安全保护元器件 提供电路安全解决方案
Providing a Total Solution for High Standard Safety Circuit Protection

WHAT

CAN DO FOR YOU

赛尔特设计、制造、销售业界领先的**电路控制及安全保护元器件**、提供**电路安全解决方案**。

2000年成立于中国厦门。产品销往40多个国家和地区，与世界500强的部分企业有深远的合作，首创、独创多个产品；取得CCC、UL、cUL、VDE、TUV、PSE、KC等认证，符合RoHS、REACH，获得IATF16949、ISO9001、ISO14001、ISO45001、GB/T29490管理体系认证，参与多项电路保护元器件的国家、国际标准制定、修订。

赛尔特(SETsafe | SETfuse)产品的主要应用市场：通信、防雷器、电源、新能源、照明、家电、移动设备、医疗。

MISSION

PROVIDING A TOTAL SOLUTION FOR HIGH STANDARD SAFETY CIRCUIT PROTECTION.

SETsafe | SETfuse was established in 2000 in Xiamen, China. We have a presence in more than 40 countries and regions recognising our products. Some of the world's 500 fortune companies are our valuable customers. We have pioneered, innovated & developed several products exclusively. Products are compliance with CCC, UL, cUL, VDE, TUV, PSE, KC, IATF16949, ISO9001, ISO14001, ISO45001, GB/T29490 certificates. We are in one of the core participating teams for revising and setting several national & international standards in the field of Circuit Protection.

SETsafe | SETfuse Key Markets: Telecom, Surge Protector, Power, New Energy, Lighting, Home Appliances, Mobile Devices, Medical.

过温保护 Over Temperature Protection

ATCO
温度保险丝 Thermal-Link 1



DC-ATCO
直流温度保险丝 Thermal-Link 2



OTCO
温度保险丝 Thermal-Link 3



TMS
热保护器 Thermal Protector 4



过电压保护 Over Voltage Protection

TVS Diodes
瞬态电压抑制二极管 Transient Voltage Suppression Diodes 1

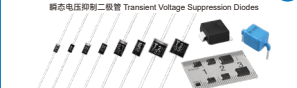

GDT
气体放电管 Gas Discharge Tube 2



MOV
压敏电阻 Metal Oxide Varistor 3



TFMOV
热保护型压敏电阻 Thermal Fuse & MOV 4



TFMOV
热保护型压敏电阻 Thermally Protected Varistors 5



过电压保护 Over Voltage Protection

SPD-M
电涌保护模块 Surge Protective Device Module 6



SPD
低压电源系统 Low-voltage Power Systems 7



SPD
光伏供电系统 PV System 8



SPD
室外照明系统 Outdoor Lighting 9



SPD
信号通信系统 Signaling Networks 10



过电流保护 Over Current Protection

Mini Fuses
小型熔断器 Miniature Fuses 1



TRXF
热保护型熔断电阻器 Thermal-Link & Fusing Resistor 2



TPR
热保护型熔断电阻器 Thermally Protected Resistor 3



NTC
抑制浪涌电流NTC热敏电阻器 Inrush Current Limiting NTC Thermistor 4



LV Fuses
低压熔断器 Low Voltage Fuses 5



主动保护 Active Protection

iTCO
受控熔断器 Iode Thermal-Link 1



受控熔断器 idea Thermal-Link (iTCO)

特性 Features

- | | |
|--------------------------|--|
| · 低阻抗 ,低功耗 | Low Impedance, Low Power Consumption |
| · 一次性动作而不可复位 | Non-Resettable |
| · 优越的抗振性 | Superior Vibration Resistance |
| · 主动控制功能 | Active Control |
| · 过温保护 | Over Temp. Protection |
| · 自控保护 | Self-Control Protection |
| · 额定动作温度: (102 ~ 150) °C | Rated Functioning Temp. : (102 ~ 150) °C |
| · 额定电流: (20 ~ 200) A | Rated Current: (20 ~ 200) A |
| · 额定电压: (100 ~ 400) VDC | Rated Voltage : (100 ~ 400) VDC |
| · 专利产品 | Patented Product |

应用 Applications

- | | |
|--------------|--------------------------------------|
| · 电池控制单元失效保护 | Battery Control Unit Fail Protection |
| · 大功率固态继电器 | High Power Solid State Relays |
| · PTC加热器 | PTC Heaters |

结构图 Structure

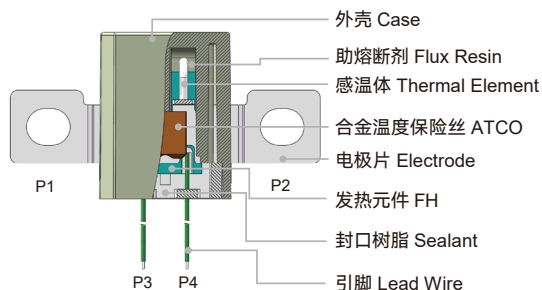

原理图 Schematic

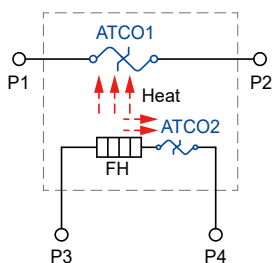

P1-P2	主电路 Main Circuit
ATCO1	承载电流、分断电路 Carrying Current, Breaking Circuit
P3-P4	控制电路 Control Circuit
FH	提供熔断热源 Providing heat source for fusing
ATCO2	加热自我保护 Self protection for FH

TPHxxx-R 系列 Series

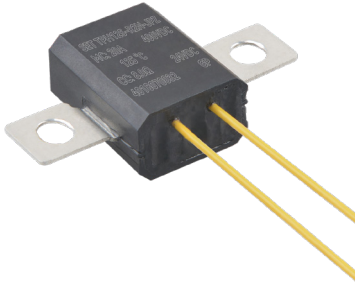

尺寸图 Dimensions (mm)

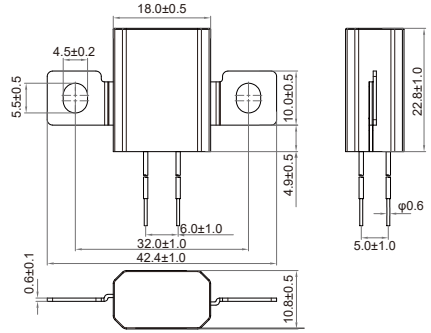

技术参数 Specification

主电路参数 Main Circuit Parameters			控制电路参数 Control Circuit Parameters		熔断时间 Fusing Time		RoHS REACH
额定动作温度 T_i	额定电流 I_r	额定电压 U_r	额定电压 U_c	阻值 Resistance	t_{mc}	t_{cc}	
(°C)	(A)	(V)	(V)	(Ω)	(s)	(s)	
102 ~ 150	20	DC 400	24	8.0	≤ 60	$t_{mc} + (0 \sim 30)$	●

JSxxx-R 系列 Series

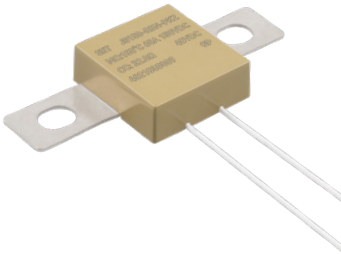

尺寸图 Dimensions (mm)

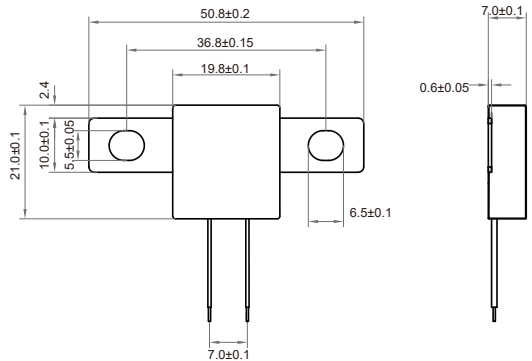

技术参数 Specification

主电路参数 Main Circuit Parameters			控制电路参数 Control Circuit Parameters		熔断时间 Fusing Time		 RoHS REACH
额定动作温度 T_i	额定电流 I_r	额定电压 U_r	额定电压 U_c	阻值 Resistance	t_{mc}	t_{cc}	
(°C)	(A)	(V)	(V)	(Ω)	(s)	(s)	
150	30 / 40 / 60	DC 150	12 ~ 72	8 ~ 50	≤ 60	$t_{mc} + (0 \sim 30)$	● ●

TKT-R 系列 Series

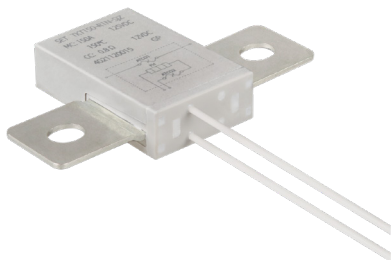

尺寸图 Dimensions (mm)

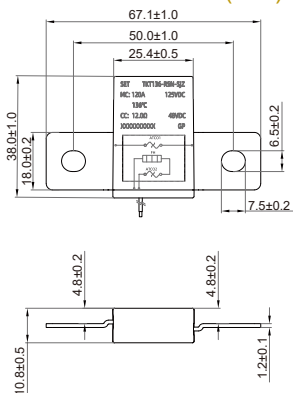

技术参数 Specification

主电路参数 Main Circuit Parameters			控制电路参数 Control Circuit Parameters		熔断时间 Fusing Time		UL [®]	cUL [®]	RoHS REACH
额定动作温度 T_r	额定电流 I_r	额定电压 U_r	额定电压 U_c	阻值 Resistance	t_{mc}	t_{cc}			
(°C)	(A)	(V)	(V)	(Ω)	(s)	(s)	UL	cUL	
136	120	DC 125	12 ~ 96	0.8 ~ 50	≤ 60	$t_{mc} + (0 \sim 30)$	●	●	●
150	150								

TKS-R 系列 Series

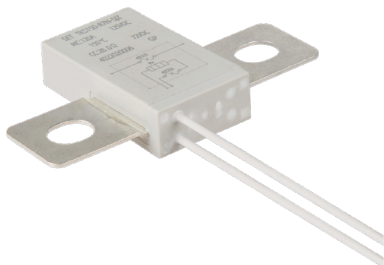

尺寸图 Dimensions (mm)

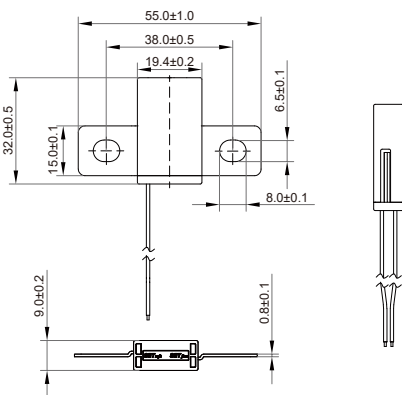

技术参数 Specification

主电路参数 Main Circuit Parameters			控制电路参数 Control Circuit Parameters		熔断时间 Fusing Time		UL [®]	cUL [®]	RoHS REACH
额定动作温度 T_r	额定电流 I_r	额定电压 U_r	额定电压 U_c	阻值 Resistance	t_{mc}	t_{cc}			
(°C)	(A)	(V)	(V)	(Ω)	(s)	(s)	UL	cUL	
150	120	DC 125	12 ~ 96	0.8 ~ 50	≤ 60	$t_{mc} + (0 \sim 30)$	●	●	●

THTxxx-R 系列 Series

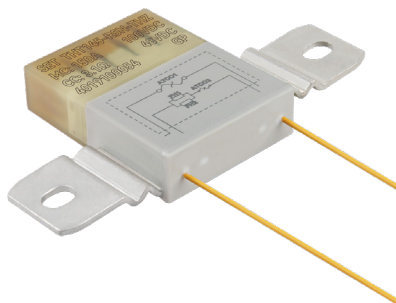

尺寸图 Dimensions (mm)

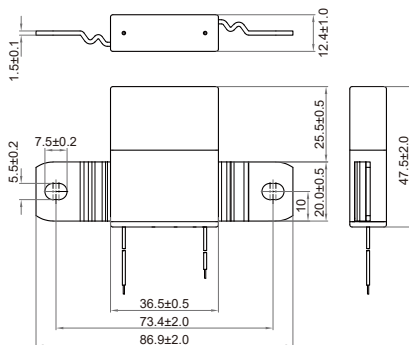

技术参数 Specification

主电路参数 Main Circuit Parameters			控制电路参数 Control Circuit Parameters		熔断时间 Fusing Time		RoHS REACH
额定动作温度 T_i	额定电流 I_r	额定电压 U_r	额定电压 U_c	阻值 Resistance	t_{mc}	t_{cc}	
(°C)	(A)	(V)	(V)	(Ω)	(s)	(s)	
125 ~ 150	150	DC 100	12 ~ 48	0.6 ~ 6.0	≤ 60	$t_{mc}+(0 \sim 30)$	●

THUxxx-R 系列 Series

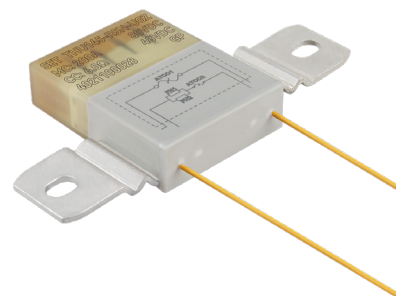

尺寸图 Dimensions (mm)

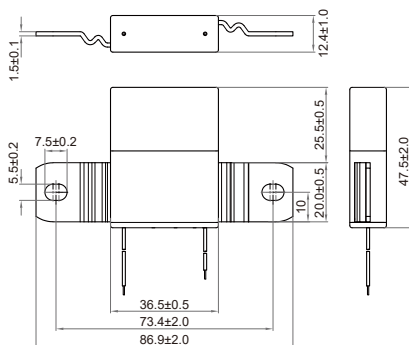

技术参数 Specification

主电路参数 Main Circuit Parameters			控制电路参数 Control Circuit Parameters		熔断时间 Fusing Time		RoHS REACH
额定动作温度 T_i	额定电流 I_r	额定电压 U_r	额定电压 U_c	阻值 Resistance	t_{mc}	t_{cc}	
(°C)	(A)	(V)	(V)	(Ω)	(s)	(s)	
125 ~ 150	200	DC 80	12 ~ 48	0.6 ~ 6.0	≤ 60	$t_{mc}+(0 \sim 30)$	●

电流-时间曲线 Current-Time Curve

TPHxxx-R Series

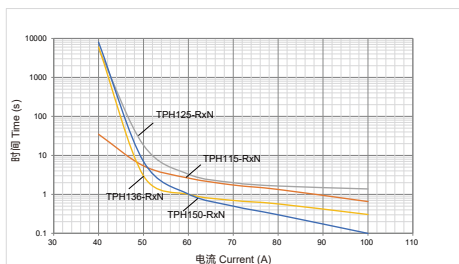

JSxxx-R Series

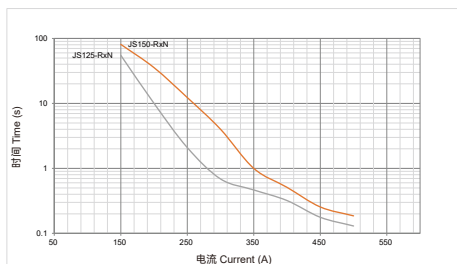

TKT-R Series

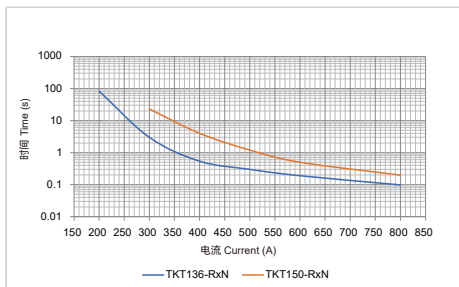

TKS-R Series

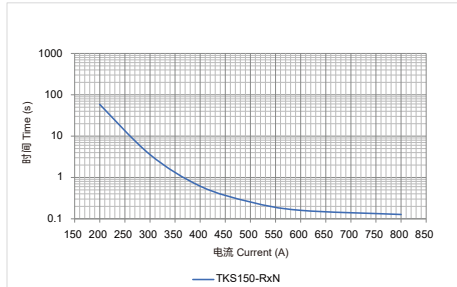

THTxxx-R Series

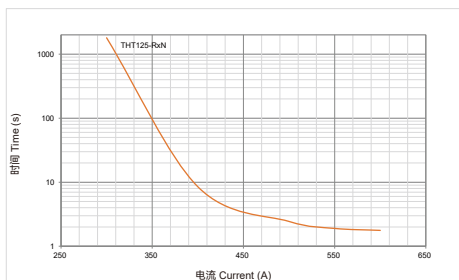

THUxxx-R Series

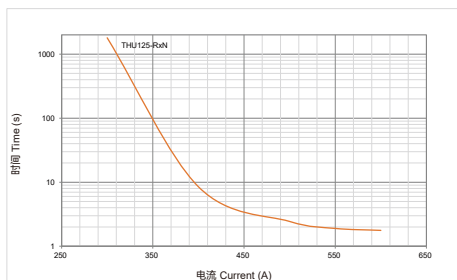

应用 Applications

MCU可检测电池组的电压、电流、温度，当出现继电器/IGBT等控制单元异常时，MCU控制iTCO执行切断。

The MCU can detect the voltage, current, and temperature of the battery pack. When there is an abnormality in the control unit such as a Relay / IGBT, the MCU controls the iTCO to perform a shutdown.

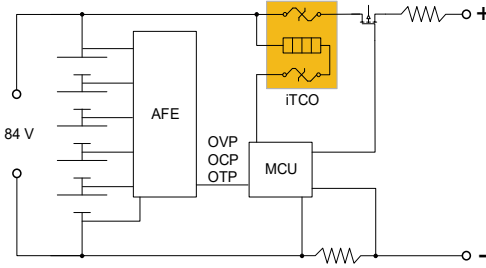

特殊车辆和轮船使用的是一种24 V 锂离子可充电电池，可用于启动柴油发动机，并用于频繁的怠速停止操作。

它具有内置的保护电路（BMS：电池管理系统），可监视电池电压和温度，并防止过电流，过充 / 过放和过热。

BMS检测异常时，可控制iTCO执行线路的切断，及过电流熔断功能。

Special vehicles and ships use a 24 V lithium ion rechargeable battery that can be used to start diesel engines and for frequent idling and stopping operations.

It has a built-in protection circuit (BMS: Battery Management System), which can monitor battery voltage and temperature, and prevent overcurrent, overcharge / over discharge and over-temperature.

When the BMS detects an abnormality, it can control the iTCO to perform circuit cutoff and over-current fuse function.

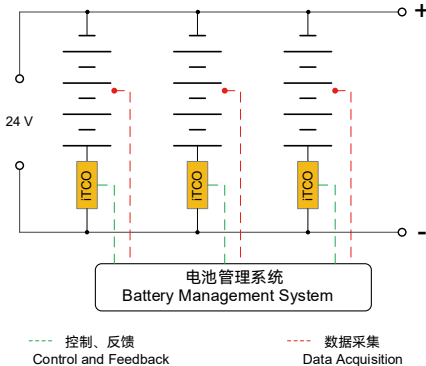

温度保险丝

Thermal-Link (DC-ATCO)

特性 Features

- | | |
|-------------------------|--|
| · 额定电流: (10 ~ 200) A | Rated Current: (10 ~ 200) A |
| · 额定电压: (60 ~ 850) VDC | Rated Voltage: (60 ~ 850) VDC |
| · 额定动作温度: (76 ~ 230) °C | Functioning Temperature: (76 ~ 230) °C |
| · 低阻抗, 低功耗 | Low Impedance, Low Power Consumption |
| · 一次性动作不可复位 | Non-resettable |
| · 过温保护 | Over-temperature Protection |
| · 优越的抗振动 | Superior Vibration Resistance |
| · 满足汽车禁用物质要求 | Meet The Requirements of Vehicle Prohibited Substances |

应用 Applications

- | | |
|----------|-------------------------------------|
| · 电池模组 | Battery Module |
| · 空调加热系统 | Air Conditioning Heating System |
| · 电池恒温系统 | Battery Constant Temperature System |
| · 座椅加热系统 | Seat Heating System |

结构图 Structure

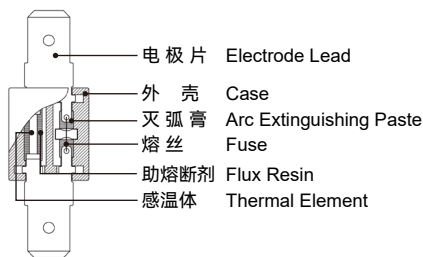
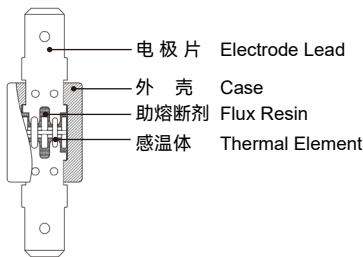

原理图 Schematic

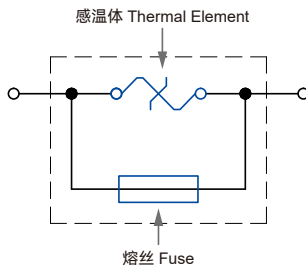
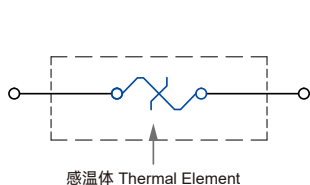

TGxxxC 系列 Series



尺寸图 Dimensions (mm)

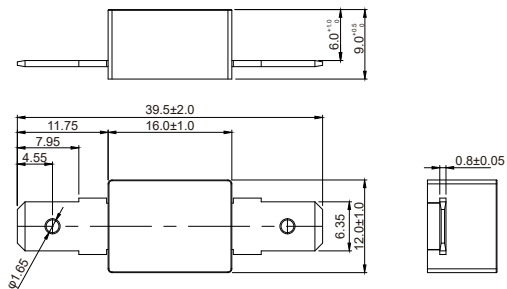

技术参数 Specification

额定动作温度 T_f	保持温度 T_h	极限温度 T_m	最小断开电流 I_{min}	额定电流 I_r	额定电压 U_r			RoHS REACH
(°C)	(°C)	(°C)	(A)	(A)	(V)	UL	CUL	
86 ~ 150	43 ~ 100	250	0	15	DC 450	●	●	●
				20	DC 400			
				20	AC 600			

TGH 系列 Series



尺寸图 Dimensions (mm)

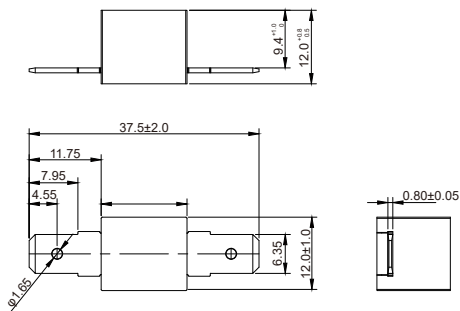

技术参数 Specification

额定动作温度 T_f	保持温度 T_h	极限温度 T_m	最小断开电流 I_{min}	额定电流 I_r	额定电压 U_r	RoHS REACH
(°C)	(°C)	(°C)	(A)	(A)	(V)	
102 ~ 187	63 ~ 155	250	3	15	DC 850	●

RQF 系列 Series

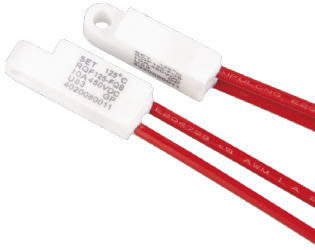

尺寸图 Dimensions (mm)

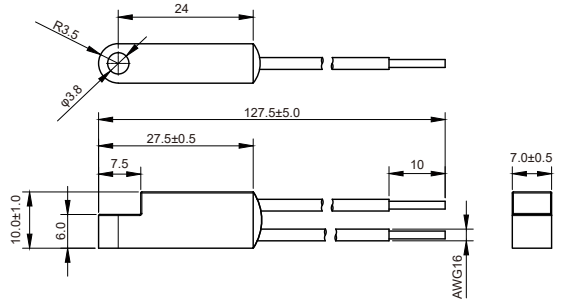

技术参数 Specification

额定动作温度 T_f	保持温度 T_h	极限温度 T_m	最小断开电流 I_{min}	额定电流 I_r	额定电压 U_r	RoHS REACH
(°C)	(°C)	(°C)	(A)	(A)	(V)	
86 ~ 187	45 ~ 155	250	3	10	DC 450	●

RVH 系列 Series

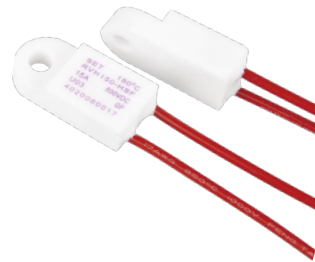

尺寸图 Dimensions (mm)

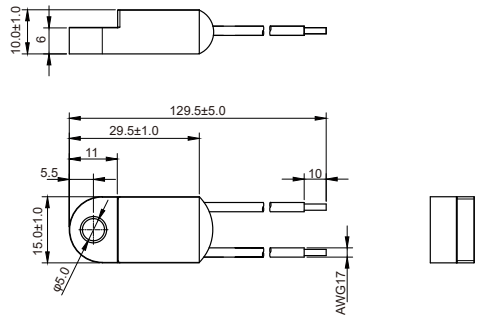

技术参数 Specification

额定动作温度 T_f	保持温度 T_h	极限温度 T_m	最小断开电流 I_{min}	额定电流 I_r	额定电压 U_r	RoHS REACH
(°C)	(°C)	(°C)	(A)	(A)	(V)	
102 ~ 187	65 ~ 160	250	0.5	15	DC 600	●

ASLxxxA 系列 Series

尺寸图 Dimensions (mm)

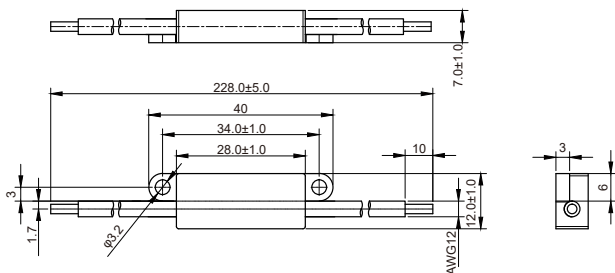

技术参数 Specification

额定动作温度 T_f	保持温度 T_h	极限温度 T_m	最小断开电流 I_{min}	额定电流 I_r	额定电压 U_r	RoHS REACH
(°C)	(°C)	(°C)	(A)	(A)	(V)	
102 ~ 187	55 ~ 140	250	0.5	30	DC 600	●

ARL 系列 Series

尺寸图 Dimensions (mm)

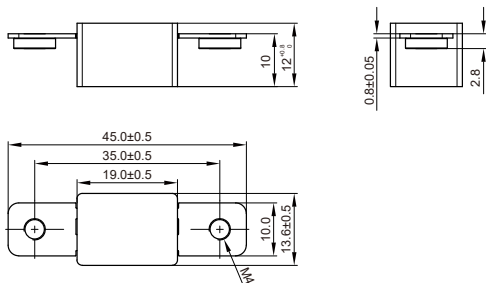
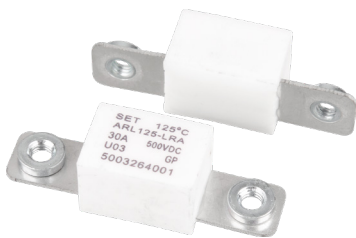

技术参数 Specification

额定动作温度 T_f	保持温度 T_h	极限温度 T_m	最小断开电流 I_{min}	额定电流 I_r	额定电压 U_r	RoHS REACH
(°C)	(°C)	(°C)	(A)	(A)	(V)	
86 ~ 187	45 ~ 125	250	0	30	DC 500	●

SL 系列 Series

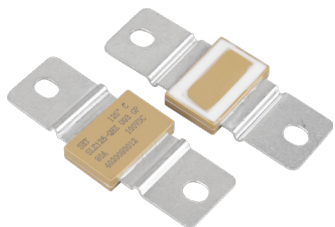

尺寸图 Dimensions (mm)

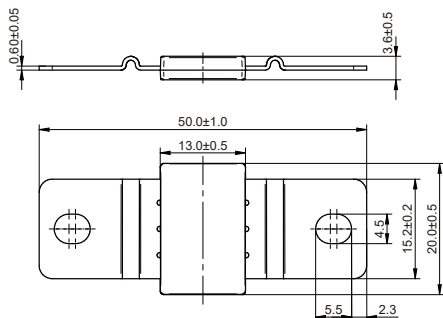

技术参数 Specification

额定动作温度 T_f	保持温度 T_h	极限温度 T_m	最小断开电流 I_{min}	额定电流 I_r	额定电压 U_r	RoHS REACH
(°C)	(°C)	(°C)	(A)	(A)	(V)	
102 ~ 136	57 ~ 91	180	0	50	AC 125	●
					DC 100	

TB 系列 Series

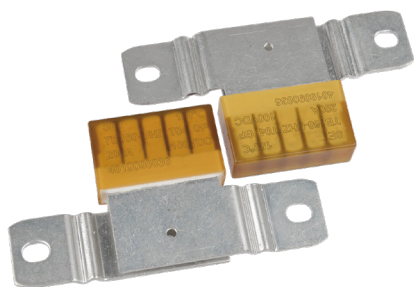

尺寸图 Dimensions (mm)

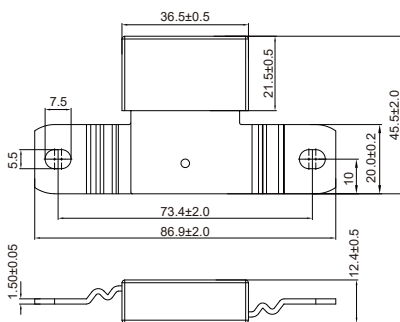

技术参数 Specification

额定动作温度 T_f	保持温度 T_h	极限温度 T_m	最小断开电流 I_{min}	额定电流 I_r	额定电压 U_r	RoHS REACH
(°C)	(°C)	(°C)	(A)	(A)	(V)	
102 ~ 136	57 ~ 91	180	0	200	AC125	●
					DC 100	

电流时间曲线 Current-Time Curve

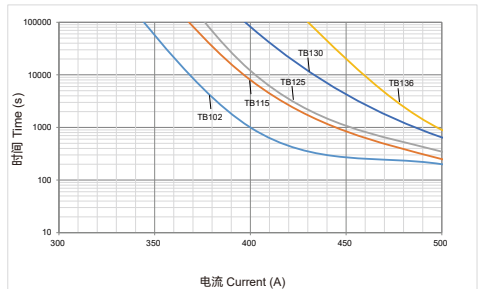
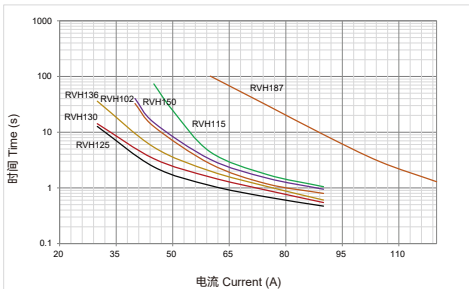
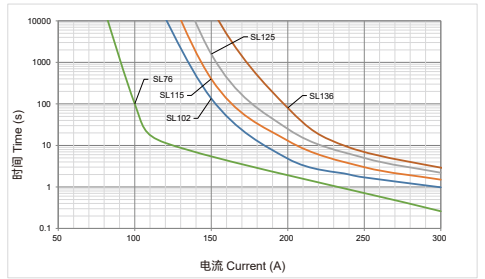
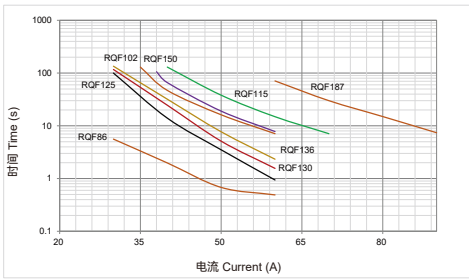
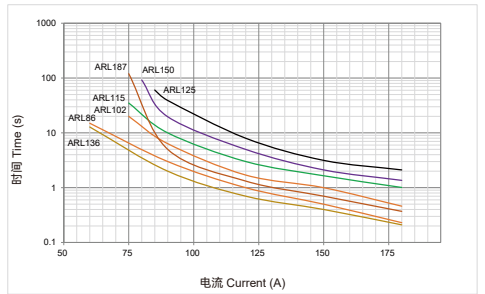
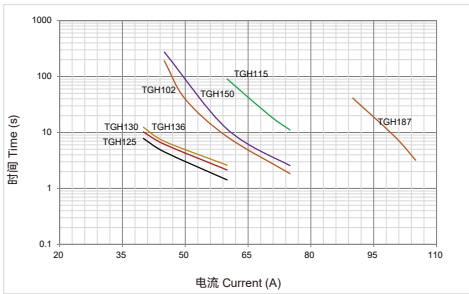
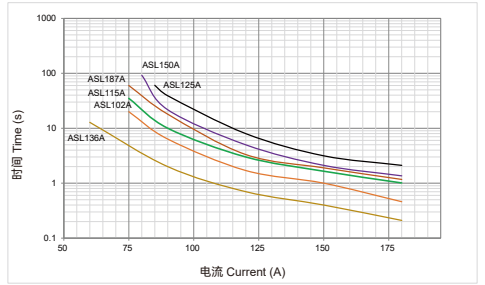
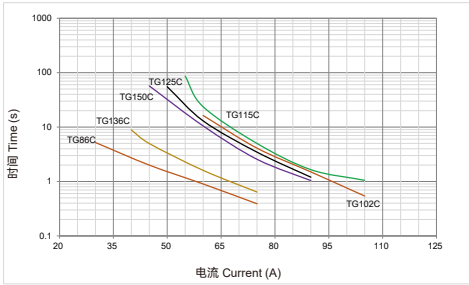

应用 Applications

电池恒温系统中，冷却液循环管出现泄漏时，加热器出现干烧，由DC-ATCO进行最后一级热失控保护；
In the battery constant temperature system, when the coolant circulation pipe leaks, the heater will burn dry, and DC-ATCO will perform the final thermal runaway protection;

高压加热回路出现继电器/IGBT等控制单元失效时，加热回路无法控制，DC-ATCO作为高压加热回路的二级保护。
When the control unit such as relay/IGBT fails in the high-pressure heating circuit, the heating circuit cannot be controlled, and DC-ATCO is used as the secondary protection of the high-pressure heating circuit.

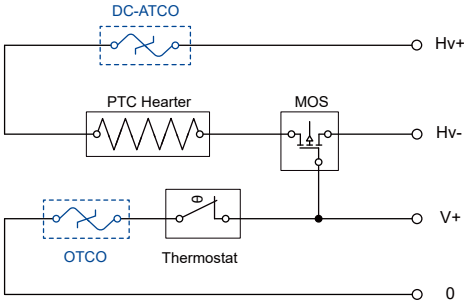

模拟加热器干烧保护温升曲线

Simulated Heater Dry Burning Protection Temperature Rise Curve

TG115C

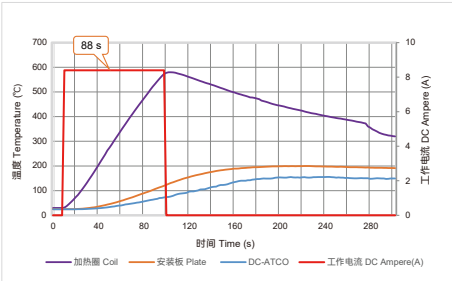

TG125C

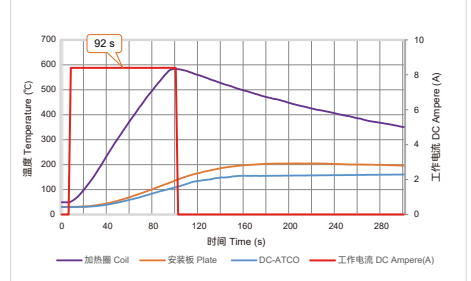

TG136C

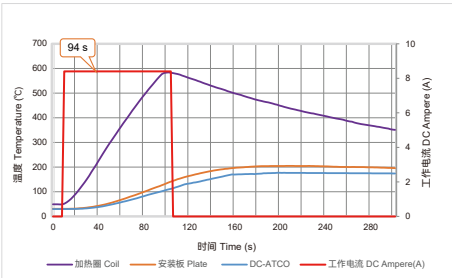

TG150C

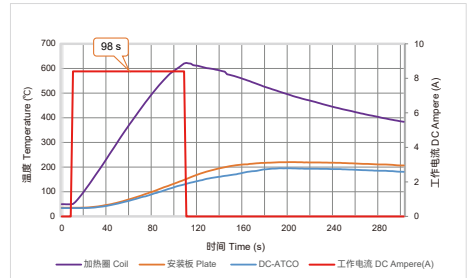

www.SETsafe.com
www.SETfuse.com

20+

OVER 20 YEARS OF DESIGNING, MANUFACTURING
AND SELLING OF CIRCUIT PROTECTION COMPONENTS
超过20年的设计、制造、销售电路保护元器件

40+

SOLD TO MORE THAN 40 COUNTRIES AND REGIONS
40多个国家和地区的客户选择赛尔特品牌

自动化

AUTOMATIC PROCESS PRODUCTION
自动化工序生产

500

A BRAND CHOSEN BY FORTUNE 500 COMPANIES
世界500强企业选择品牌



厦门火炬高新区（翔安）产业区翔安西路8067, 8001号
NO. 8067, 8001 West Xiang'an Road, Torch High-Tech
Industrial District, Xiang'an 361101 Xiamen P.R. China
www.SETsafe.com www.SETfuse.com
+ 86 592-5715-838 sales@SETfuse.com

厦门赛尔特电子有限公司版权所有
All Rights Reserved by Xiamen SET Electronics Co., Ltd.
更新 Update: Jun 2, 2022

SET safe | *SET fuse*
赛尔特